

FirstFiber



USER GUIDE

HICOUD H720 OPTICAL TESTER

Copyright © FirstFiber Technologies 2024

PREFACE

Thank you very much for buying and using H720 series optical network tester. This manual mainly contains the commonly used operating safety instructions, basic interface and operation introduction, as well as common troubleshooting guidelines and other information. In order to facilitate your use, before operating this instrument, please read the contents of this manual carefully and follow the instructions in the book correctly.

This manual is limited to use in conjunction with this instrument. No unit or individual may alter, copy or disseminate the contents of this manual for commercial purposes without the authorization of the Company.

The contents of this manual are subject to change without prior notice. If you have any questions, please call the supplier. We will do our best to provide you with the best service.

H720 series optical network tester is the first smart and high precision optical test instrument with cloud wireless transmission, intellignet cloud platform and other functions. H720 series integrates 18 standard functional modules internally, including OTDR, Intellignet optical network map iONM, LS, VFL, OPM, Optical end face detection, Multi-core measurement, Optical loss test, File management, Data wireless transmission, RJ45 cable tracker, Laser ranging, Remote assistance, One-key repair, Camera, Bluetooth, WiFi, GPS&BDS (on developing).

H720 series has 0.8m event blind zone, maximum 45dB dynamic range, 1650nm online test (50dB isolation), 8G storage which can store 200,000 curves. It adopts 7 inch capacitive touch screen, supports multi-point touch. Compared to previous versions, it supports smart cloud platform, iONM, Multi-core measurement, Bluetooth. WIFI, 4G LTE SIM and GPS (on developing), and test data can be uploaded to the cloud wirelessly. PDF reports can be generated on the device and transmit them to the mobile terminal via WiFi & Bluetooth. H720 series supports multi-tasks simultaneous operation, and VFL, OPM, LS functions can run in the background.

OTDR Interface,function introduction

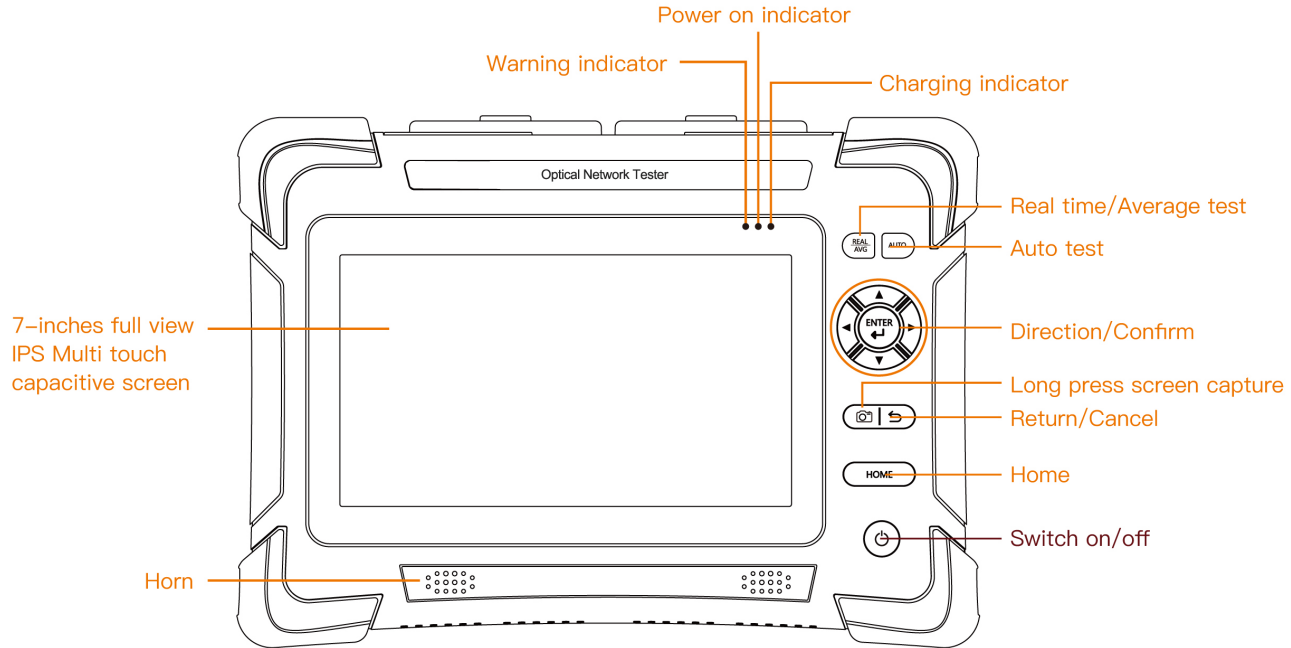

OTDR Interface,function introduction

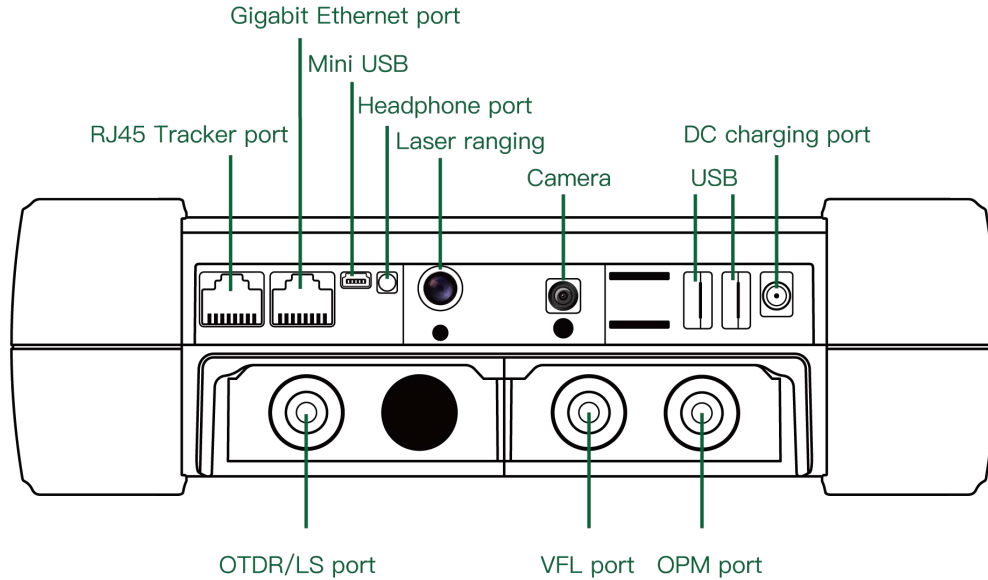

- **Mini USB connection**: Connect the computer for data export, or connect the power bank to charge the device
- **USB connection**: Accessing USB flash disk to export data, used as a power bank function to charge other devices
- **DC charging port**: Charging voltage range 12V~19V

OTDR Interface,function introduction

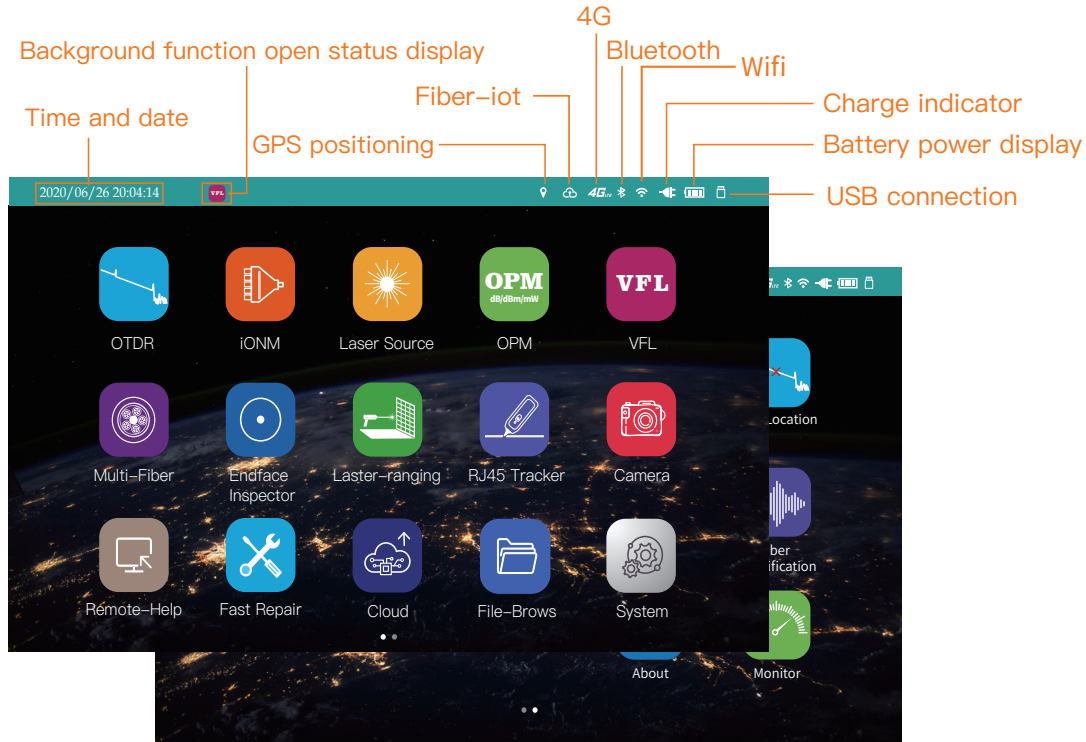

Note: the main page is a sliding page, and the second page appears on the left

OTDR Interface,function introduction

Multi task simultaneous operation Curve thumbnail

Multi task area

Curve full screen

Event map

OPM VFL LS

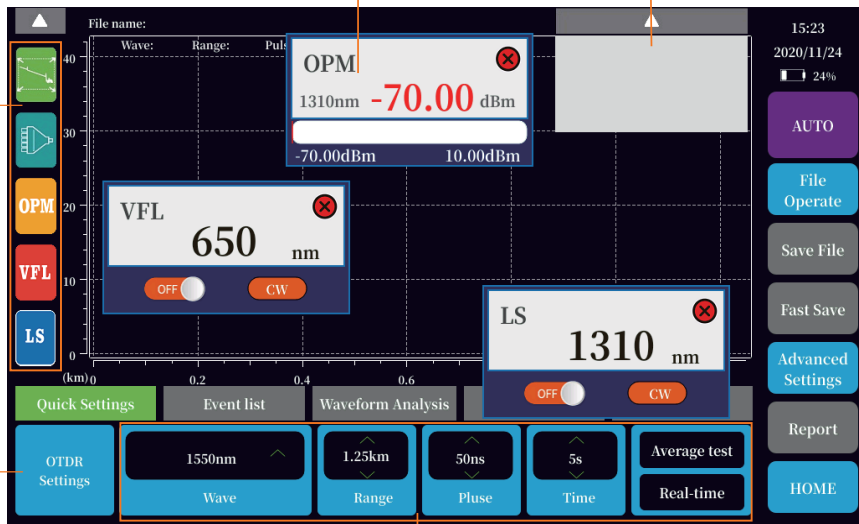

Optical fiber characteristic setting

Pass/Fail Settings

Measure Settings

Analysis/Save Settings

Quick setting, no need to stop to modify conditions, convenient and fast

15:23

2020/11/24

24%

AUTO

File Operate

Save File

Fast Save

Advanced Settings

Report

HOME

One button auto test

File operation

Preview / wireless upload to cloud

File save

Support Chinese and English input

One click save

Convenient and quick

Advanced setting

High end setting function

Generating reports

Generate PDF report on device side

Home

Return to the main interface

iONM Interface, function introduction

- Through multi wavelength and multi pulse width combination test technology, the accurate analysis of various events is realized.

Graphic display type
More intuitive and accurate
Observe event information

List display

Type
Position length
loss
Reflect
Attenuation

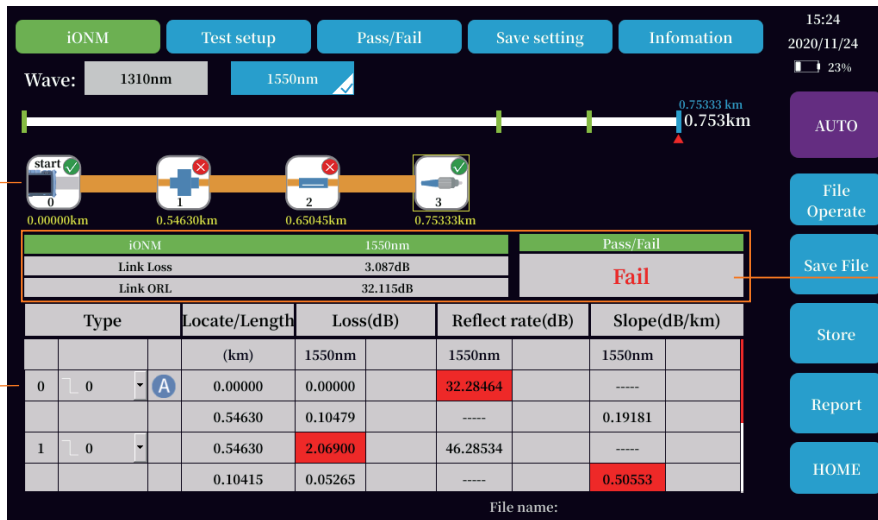

Pass/Fail
Link-loss
Link ORL

Multi core measurement

The purpose of multi-core measurement is to help customers manage and maintain multi-core optical cable data. Through the establishment of the project, to help customers more intuitively manage and maintain fiber optic data. From the core matrix, the state of all the cores can be seen intuitively, including whether it has been tested, does the test pass. Each fiber core contains OTDR data, optical fiber end face data, optical power data and test field pictures.

Project name:yu

	1	2	3	4	5	6	7	8	
	9	10	11	12	13	14	15	16	
pre page	17	18	19	20	21	22	23	24	next page
	25	26	27	28	29	30	31	32	
	33	34	35	36	37	38	39	40	

Current core:19

Wave1: 1310nm
Wave2: 1550nm
Range: 1.25 km
Pulse: 50ns

850nm -67.68dB

17:48
2020/11/24
55%

New
Open
Attribute
Scene Picture
Fiber Operate
Open file
HOME

Core matrix

New project

Open project

Project property

Pictures of the scene

Core operation

Open file

Home

Measurement information

Waveform Preview

End face detection

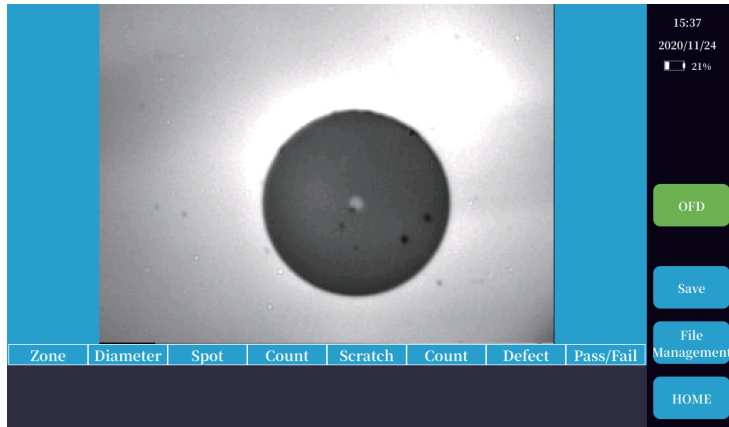

Save and view the optical fiber end face image

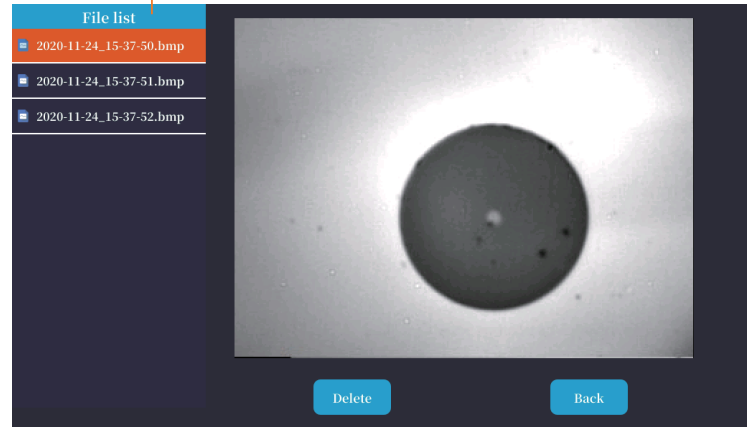

- The core diameter of single-mode fiber is about 9 μ m, It's thinner than human hair, If the end face is polluted, it will cause great connection loss, this leads to unstable communication state. It has great influence on the confidence of OTDR test results, therefore, the end face of optical fiber is tested, and cleaning is very necessary

Background prompt of Laser Source on state

LS port location

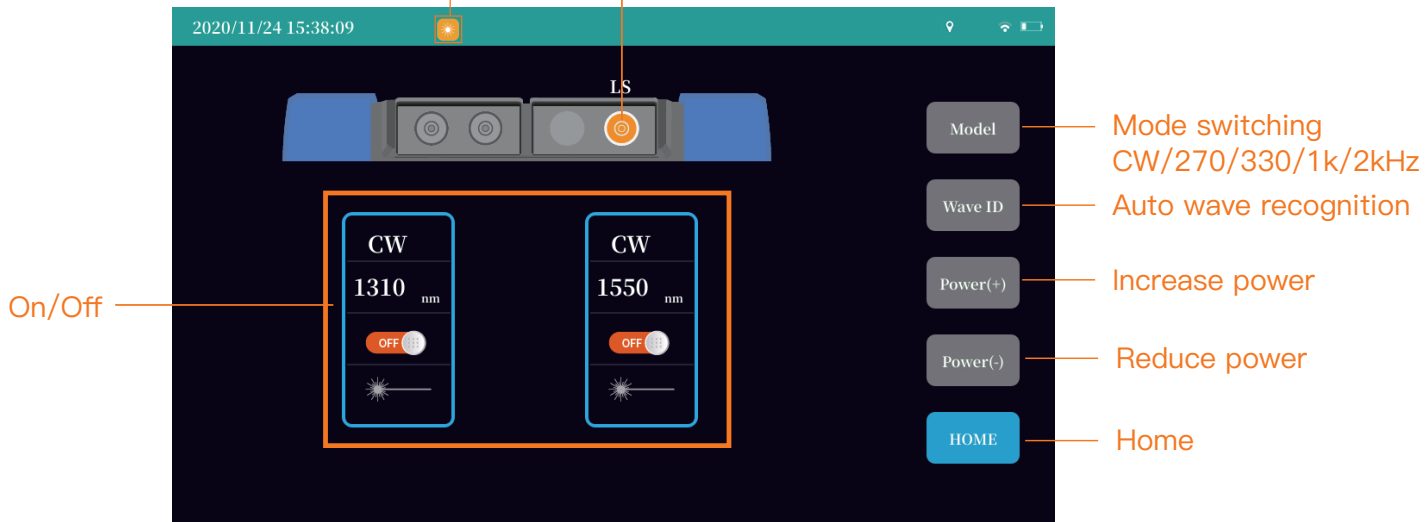

- Power adjustable stable laser source
- Output CW/270Hz/330Hz/1kHz/2kHz mode
- Support automatic wavelength recognition function, wavelength ID mode,
Combined with optical power meter module of series equipment for automatic wavelength identification

OPM port location



Measurement information

- Support frequency identification function
- Support pass / fail threshold setting
- Support Tone Detect function, namely frequency identification function

OPM data acquisition interface

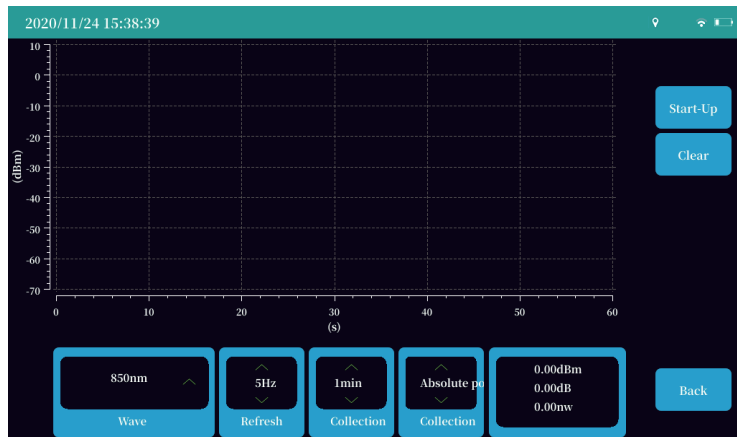

- User calibration
- Data acquisition
- Automatic wavelength recognition

Visual fault location

Background prompt of VFL state

VFL port location

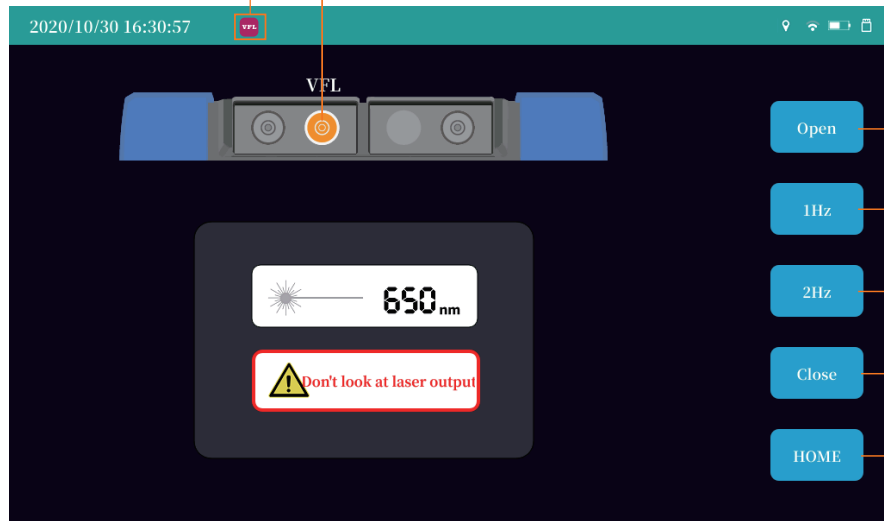

Open — VFL always bright

1Hz — VFL 1Hz twinkle

2Hz — VFL 2Hz twinkle

Close — Close VFL

HOME — Home

● Fault location and identification for short distance optical fiber

Laser ranging interface:

Please do not look directly at the laser emission port to avoid damage

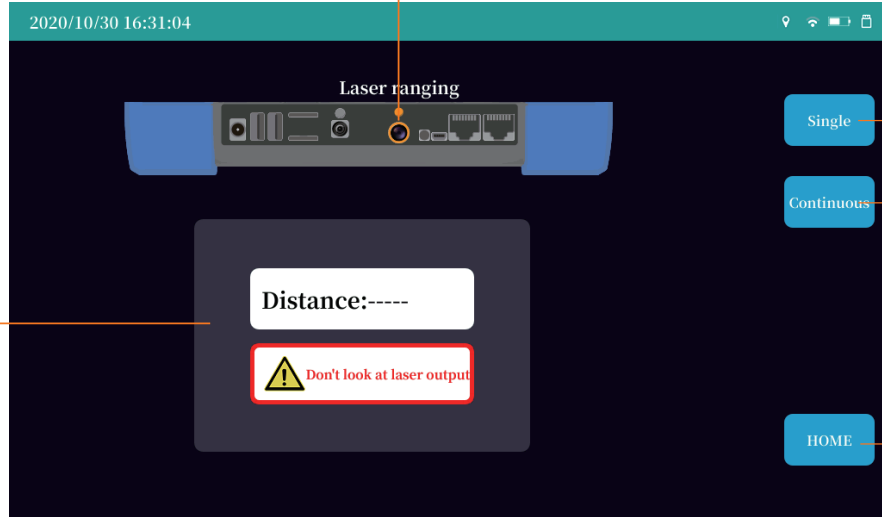

Single measurement

Continuous measurement

Home

Measurement information

● Length measurement for optical cable laying and broadband installation

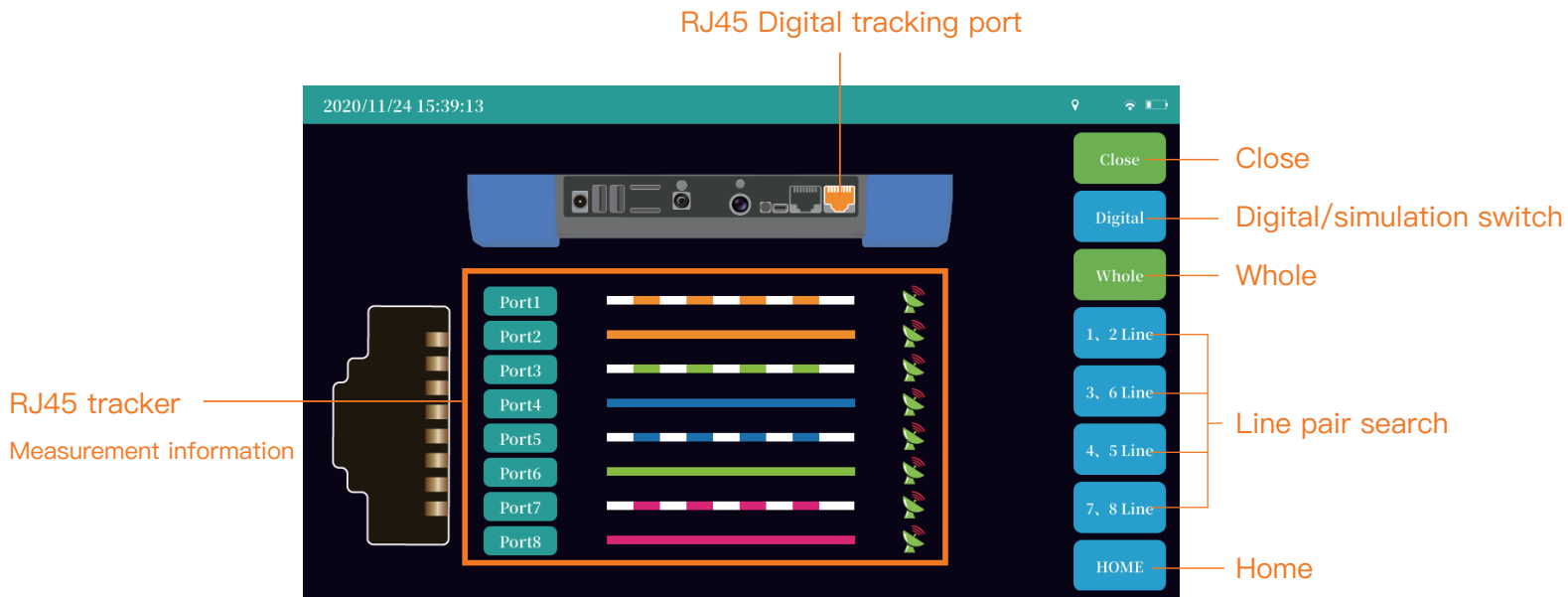

- RJ45 digital radar tracking function can be used for digital line finding of network line, telephone line and other cables

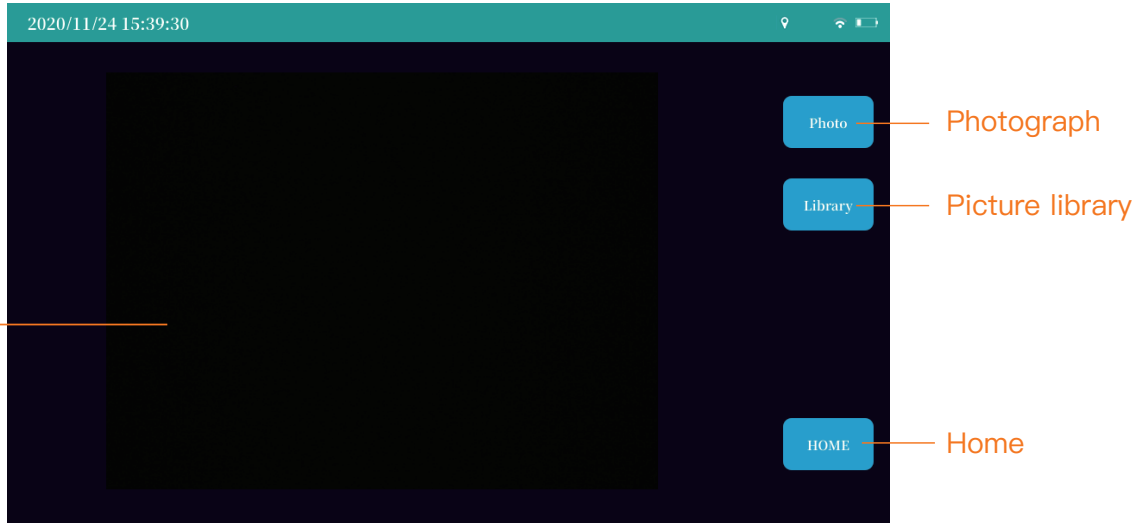

- Take pictures of the test site and link them to the OTDR test data

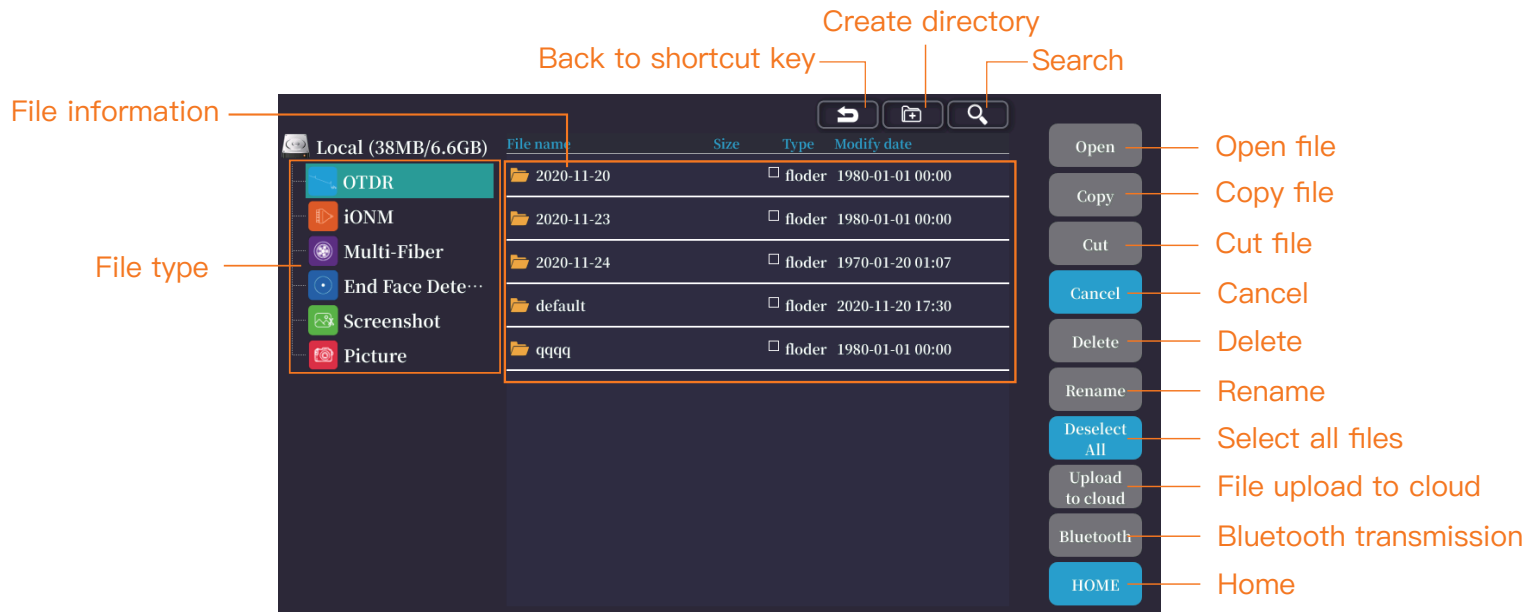

- Browse device files
- File add delete move rename
- Export files through USB flash disk
- File upload to cloud platform

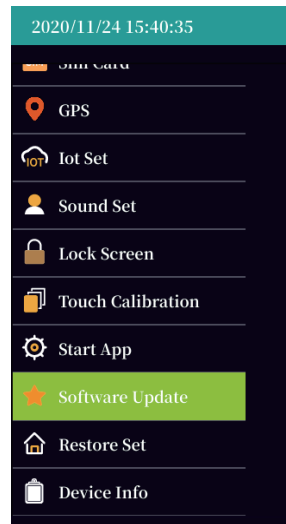
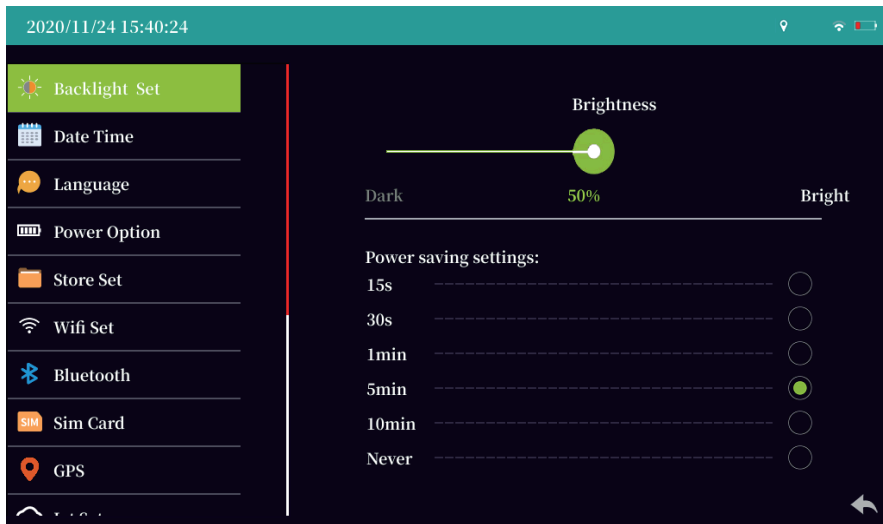

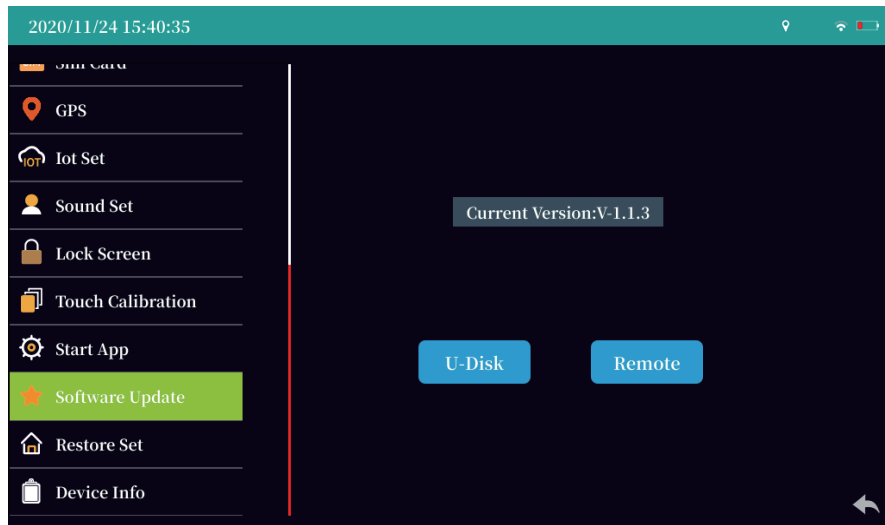

- Insert the U disk of storage upgrade software to upgrade the system
- Connect WiFi remote upgrade

Fiber-iot OTDR advanced simulation tools

The screenshot displays the Fiber-iot OTDR advanced simulation tool interface. At the top, there is a navigation bar with a logo and the text "智慧光云 FIBER-IOT". Below the navigation bar, there are buttons for "Return", "Print", and "Application".

The main content area is divided into several sections:

- Report Settings:** Includes fields for "Logo" (my logo) and "The name of the report" (my report name).
- Statistical reports:** A list of report sections including Job information, Test conditions, Analyze the conditions, Pass/Fail condition, The test results, Event map, The list of events, The chart of the curve, Comments, Photos of the scene, Face image, and Print settings.
- Test Conditions Table:**

Test mode	Analyze the conditions	Pass/Fail Judgment Conditions
Reflection loss threshold	Echo loss 40dB	Melting loss 1dB
End loss threshold	Joint loss 5dB	Waveler 1550nm
	Average loss 1dB	The pulse width 800ns
		Distance range 8.342255km
		Group refractive
- Report Date:** 2020-11-24 15:43:41

- OTDR data can be viewed through cloud analysis, and generate reports. Powerful OTDR data report generator using smart cloud, add event map, annotation, on-site test photos, optical fiber end face photos and other detailed information in the report

Common problems and Solutions

Fault description	Cause of failure	Solutions
OTDR cannot start normally.	The battery is dead.	Charge the battery and observe the charging indicator. If the red light is displayed, continue charging. Otherwise, contact the supplier.
OTDR cannot be charged normally.	Charging conditions are not met.	Charge the instrument at 0°C~ 50°C.
	Battery or internal circuit problem.	Contact the supplier to replace the battery.
Normal curve cannot be measured.	OTDR parameters are not set correctly.	Reset the correct test parameters.
	Fiber output end face is polluted.	Clean OTDR output end face.
	Output connector of OTDR is damaged.	Connect OTDR output connector.
	Optical output connector mismatch.	Replace the matched connector.
The noise of test curve is big and the waveform is not smooth.	The connector is not connected properly.	Re connect the appropriate output interface.
	The pulse width setting is too small.	Increase the test pulse width.
Saturation (flat top) appeared in the front of the test curve.	The pulse width is too large.	Decrease test pulse width parameter.
The reflection peak at the beginning of the test curve decreased slowly.	Fiber output end face is polluted.	Clean OTDR output end face.
	Fiber output end face is polluted.	Replace OTDR output connector.
There is a tailing phenomenon.	Optical output connector mismatch.	Replace the matched connector.
The reflection peak at the end of the fiber cannot be measured.	The test range is too small.	Increase test range value.
	The pulse width is too small.	Increase test pulse width parameter.
False positive in curve analysis.	Event threshold setting is too small.	Increase the pulse and the event threshold value.
The tested fiber length is not accurate.	OTDR parameters are not set correctly.	Reset the appropriate parameters.
	The refractive index is not set accurately.	Reset fiber index.
The slope of optical fiber is not accurate.	The front and tail of the test curve is too long.	Clean OTDR output end face.
	Improper setting of cursor position.	Reset cursor point position.